



MODEL 17010

KEY FEATURES

- High precision output and measurement up to $\pm 0.015\%$ of full scale
- Fast current response up to $100\mu\text{S}$
- High sampling rate up to 10mS
- High single point transient sampling rate up to 1mS
- Integrating up to 96 channels
- Channel parallel output up to 1200A
- High-efficiency charge and discharge with low heating
- Energy recycling during discharge (AC/DC bi-directional regenerative series)
- Waveform simulation (current/power modes)
- Multi-level safety protections
- Integrable data logger and chamber
- Compliant to IEC and GB/T standards

APPLICATIONS

- Electric vehicle
- Electric scooter/bike
- Energy storage system
- Power tools
- Quality inspection
- Academic research

BATTERY RELIABILITY TEST SYSTEM MODEL 17010

Chroma 17010 Battery Reliability Test System is a high-precision system designed specifically for testing lithium-ion battery (LIB) cells, electric double-layer capacitors (EDLCs), and lithium-ion capacitors (LICs). The test equipment is suitable for product development and quality control by providing characteristic research, cycle life testing, product screening, and quality assessment.

Chroma 17010 system provides two design architecture types. The linear circuit series produce low output noise and high measurement accuracy, suitable for reliability evaluation of small and medium-sized energy storage components in development. The regenerative AC/DC bi-directional series with power saving and low heat generating features fit standard product life evaluation as well as medium and large-sized energy storage components or power battery cell testing.

The exclusive Battery Lab Expert (Battery LEx) software platform helps users to quickly reference previous sub-recipes or add new sub-recipes through a multi-level recipe structure for efficient test plan editing. The independent DUT data management function can share different DUT recipes.

Battery LEx combines both CC, CC-CV, CP, CP-CV, CV, and CR test steps, as well as C-rate, OCV-SOC, Q%, waveform simulation, and chamber control modes. This is compliant with USABC, IEC, and GB/T international test standards and fits various test applications. Tests are executed in groups, so that users can quickly obtain each group's test status and perform a variety of controls during testing, including step jumps, resume, reserved pause/start, etc.

Chroma 17010 system can integrate a high-precision and multi-functional data logger to measure temperature, voltage, and pressure in real time. The return values can serve as cut-off or protection conditions. Users can also integrate renowned environmental chambers to control the temperature and humidity. While testing, the software will check for consistencies between channel groups and issue environmental control commands for convenient operation.

Chroma 17010 system provides three safety mechanisms: software/hardware detection, equipment abnormality monitoring, and optional independent relay hardware detection to ensure the safety of LIB cells tests.



Chroma

FEATURES

High-precision & Multiple Current Range Design

■ Quick switching of current ranges:

Chroma 17010 series provide multiple current outputs and measurement range switching, fitting test plans with both large and small currents. At the start of a test step, the system will detect the output current and then automatically and quickly switch to the appropriate current range. This improves the test accuracy and resolution for highly accurate test data.

■ Automatic range switching under constant voltage mode:

Chroma 17010 linear circuit models support automatic switching of the current range in the constant voltage test mode, without any output interruption. This is perfect for applications such as float charging or potential regulation, which require long-term and highly stable testing of extremely small current output.

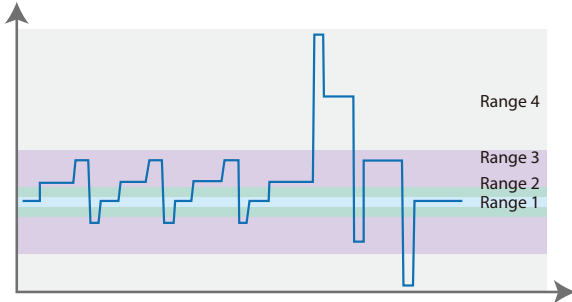

DST Application Test & Current Range
(Using 17216M-6-12 model range)

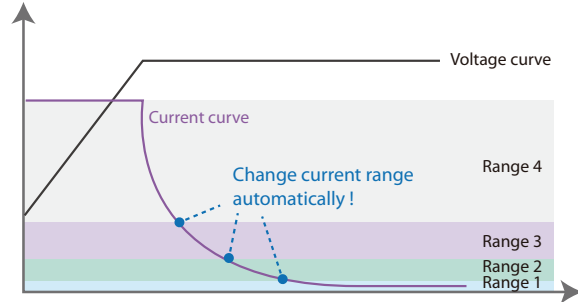

CV Test Current Switching

Stable & Low Noise Output

Chroma 17010 is equipped with low output noise and high measurement accuracy. The test current and voltage data can be converted into highly accurate and clear characteristic peaks to efficiently research the aging mechanism of Li-ion batteries.

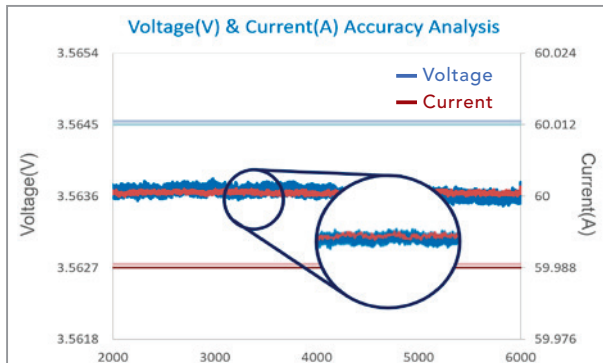

Actual Voltage/Current Measurement Accuracy

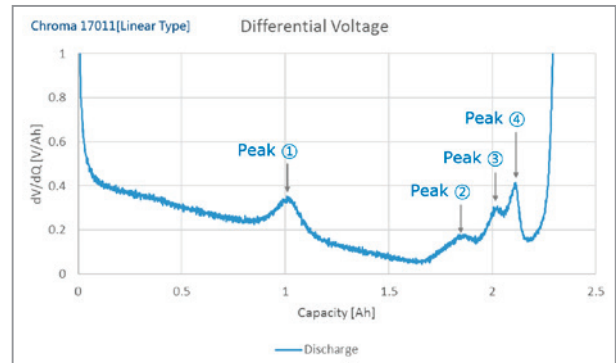

Differential Voltage Analysis Curve Test

High-speed Sampling Technology

Chroma 17010 uses high-speed voltage and current sampling with double integration of computing to capture transient changes in the test without distortion. The advanced test system provides more accurate capacity calculations to solve the issue that general battery test equipment only use the report sampling speed to record key data, causing large cumulative errors.

■ Hardware internal voltage/current sampling rate: 1mS

■ Report single point transient sampling rate: 1mS

■ Report sampling rate: 10mS

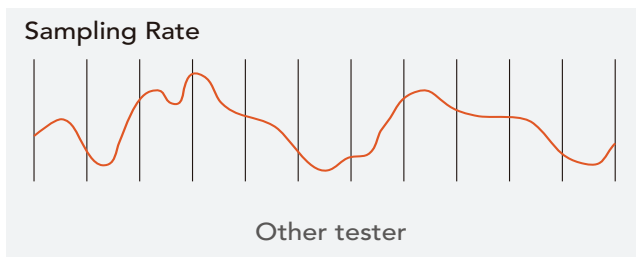

General Testers Charging/Discharging Sampling Rate

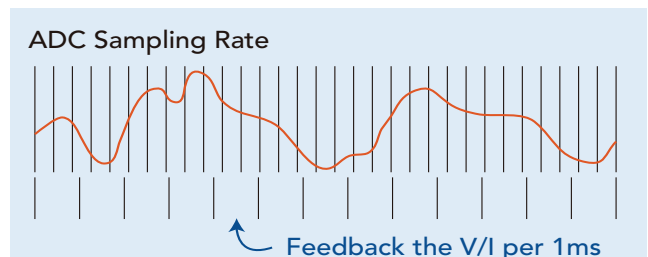

Chroma 17010 Charging/Discharging Sampling Rate

Super Charge/Discharge Output Mode

Chroma 17010 regenerative models provide up to 30 sec. super output functionality. For short-time & high-current pulse applications, the super mode can be set and executed directly through steps, and provides an even wider range of current and power usage.

- 17212M-6-100S: CC and CP 120% charge/discharge output

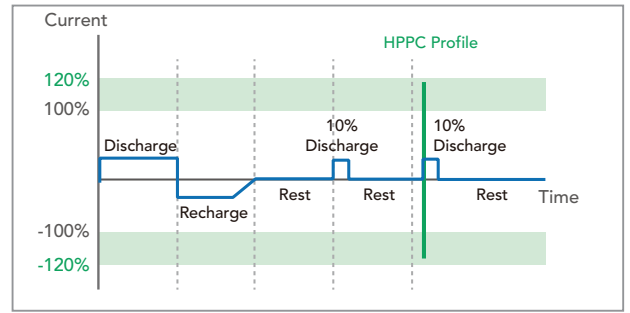

Hybrid Pulse Power Characteristic (HPPC)

Fast Current Response (<1mS)

Chroma 17010 regenerative models are provided with current response time of 0-1200A in less than 1mS, which can more realistically simulate the instantaneous peak current of battery charging and discharging behavior when driving, and also meets NEDC, FUDS, and DST test standards.

- 17212M-6-100S: 10% to 90% < 1mS

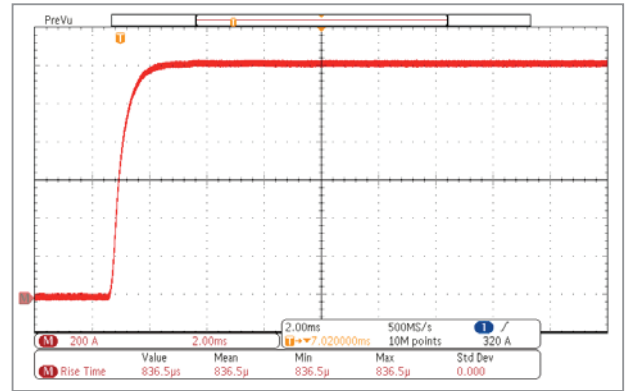

0~1200A Current Rise Time <1mS

Three Voltage Ranges

Chroma 17216M-10-6 model built in three voltage ranges, for more profuse product development applications.

- 0V~+5V: Half-cell, full-cell, EDLC testing
- 0V~+10V: Batteries in series, EDLC testing
- -5V~+5V: Symmetric battery testing

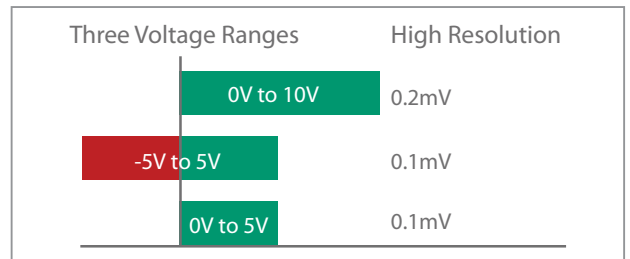

Dynamic Waveform Loading

Chroma 17010 can preload current and power dynamic charging/discharging waveforms. The system simulates acceleration, deceleration, up/downhill, and other waveforms of real-life car driving conditions and then evaluates the battery degradation and life.

- Dynamic/fixed time modes (min. output interval 10mS)
- Dynamic preloading of up to 6,400,000 data points per system

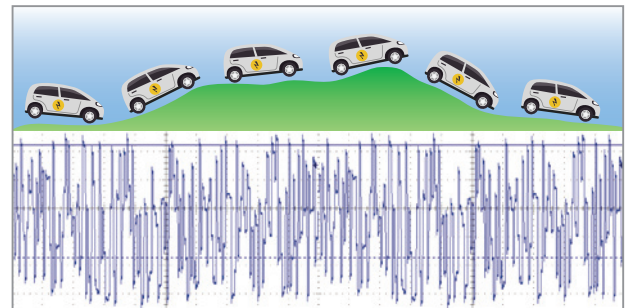

Dynamic Waveform Simulation

Energy Recycling

Chroma 17010 large current models have a high-precision, high-efficiency and power-optimized energy recycling architecture that achieve green and low-carbon performance. The test system so avoids electricity waste heat due to load consumption during discharge.

- DC: Automatically prioritize discharged energy to charging channels with >80% recycling efficiency.
- AC: Recover excess energy to the AC line, with >60% recycling efficiency.
- Feed back current to the grid with <5% total harmonic distortion.

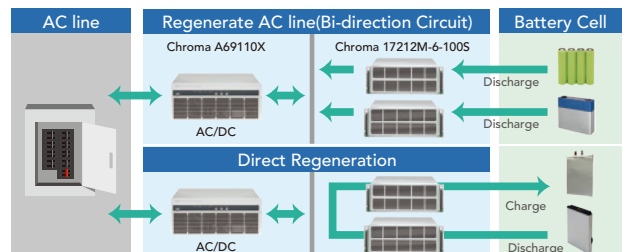

Energy Recycling Architecture

Current Parallel Output

Chroma 17010 series support dynamic parallel functionality, which can connect continuous idle channels in parallel and provide a larger current output. Their characteristics not only improve the test versatility, but also suit a variety of test objects.

Data Protection & Resume Mechanism

In case of power failure, the optional uninterruptible power supply (UPS) can temporarily store test data in the IPC database. After power is restored, the system will automatically obtain the resumed data status and continues testing from the point of disruption. The report data will not be interrupted.

SYSTEM INTEGRATION AND PROTECTION

Chroma 17010 supports integration of a variety of renowned environmental chambers and multi-functional data loggers. The Battery LEx software can simultaneously set parameters and monitor data, as well as automatically merge test data into the test report, thus providing users with the most complete test solution.

Integrable data logger

- Recording temperature (°C), voltage (V), pressure (mPa), force (kg).
- External real-time data can serve as cut-off or protection judgments (temperature).

System protection and abnormality detection

- Following the numerous built-in recipe protections, the protection mechanism monitors and triggers with a response speed of 1mS. An independent external voltage/temperature meter relay is optional to achieve reliable two-level protection.
- Real-time abnormality detection in each tester automatically detects deviations based on independent logic. When the system is interrupted, the test can be continued after the exception is eliminated without missing any data.

Integrable chamber and peripheral safety device

- The Battery LEx software provides built-in chamber setting controller and chamber control steps, which can control temperature and humidity, indicate the temperature control time, delay time, and standby temperature, as well as control timeout and over-temperature protections.
- To ensure consistency of the test state, the grouping management structure allows all testing channels in the same chamber to enter the temperature control phase at the same time.
- The built-in DI/DO function can be connected with smoke/gas detection, fire extinguisher, and alarms for over-temperature, over-voltage, and open door. The system performs different levels of handling according to the degree of damage, including stopping the test or powering off. Alarm data can be sent remotely via e-mail.

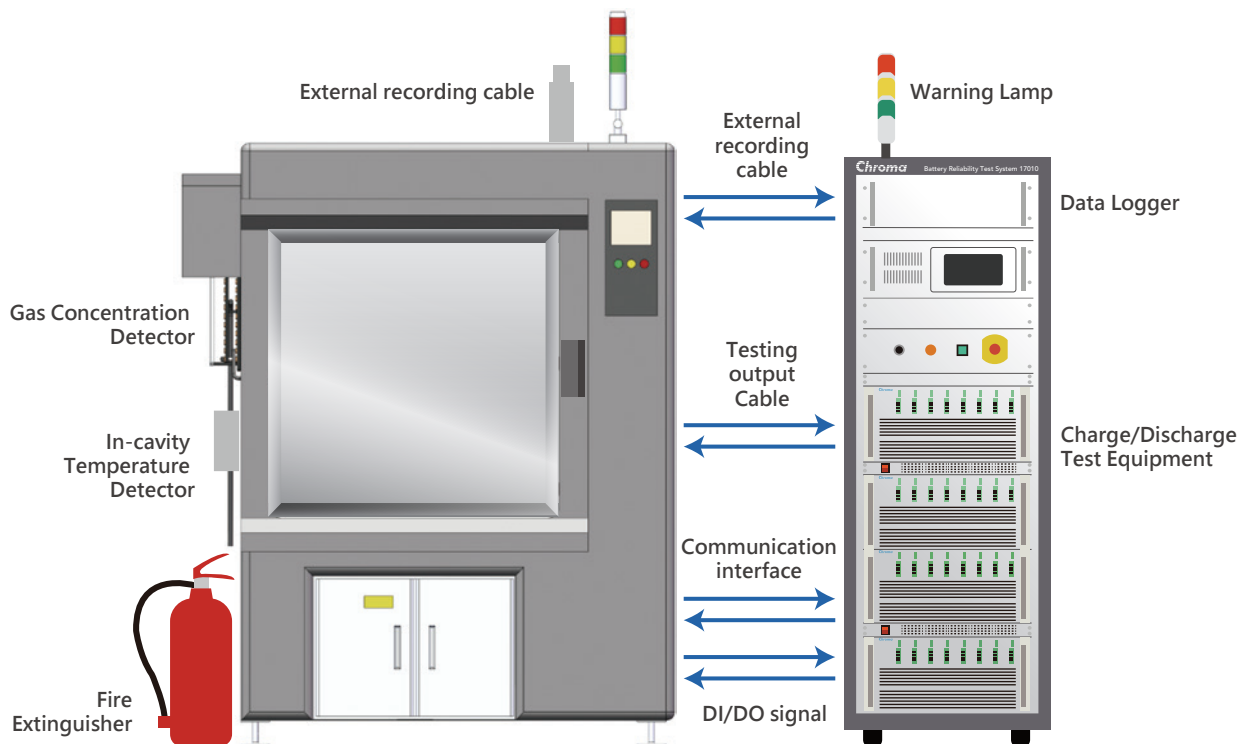

Battery Lab Expert (Battery LEx) is the testing software platform specially developed for Chroma 17010 and offers:

- Group testing: Each group can control up to 96 channels and execute up to 50,000 steps.
- Variable editing: Using the data from the external data logger for flexible programming and complex applications.
- Chamber integration: DI/DO amplification monitors the chamber's status and protection mechanisms in real time.

Project Browser

Create up to 500 projects and construct corresponding test plans according to different DUT types or requirements. The project browser allows for easy review or adjustment of the DUT specifications, waveform simulation data, and recipe content.

- DUT database: Quickly enter corresponding DUT parameters when editing a recipe, and easily share recipes to different DUTs.
- Waveform simulation folder: Import .xlsx data points to the folder, the waveform simulation can set the time interval (fixed/user defined), output magnification, and data range.
- Adjust and save parameters in real time while browsing.
- Filter keywords to search for test plans.
- Transmit test plans in .xlsx format.

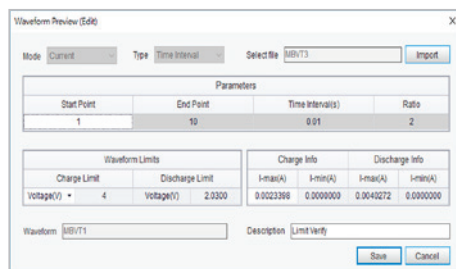

Waveform Simulation Database

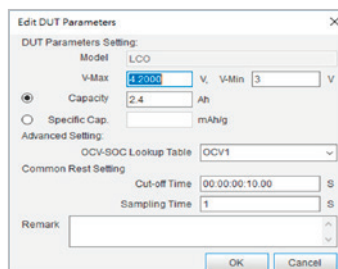

DUT Database

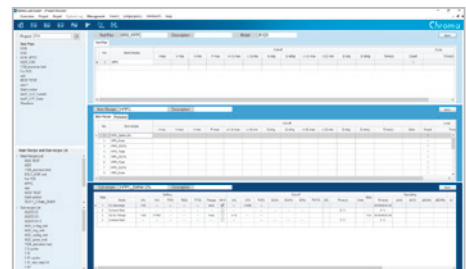

Project Browser

Recipe Editor

In the hierarchical editing structure (test plan → main recipe → sub-recipe), users can directly share existing recipes by replacing the DUT specifications or quickly complete a plan by flexibly combining existing sub-recipes. Easily create new recipes to meet various types of charge and discharge test applications.

- Step types: CC/CV/CP/CC-CV/CP-CV Charge and Discharge, CR Discharge, Current/Power Waveform, Rest, Common Rest, Chamber Control, Super CC/CP Charge and Discharge.
- Cut-off conditions: step cut-off → current, voltage, power, energy, capacity, time.
recipe cut-off → current, voltage, power, cumulative energy, cumulative capacity, time.
external cut-off parameters → each step contains up to 4 cut-off settings.
- Go to: Next, End, Jump, If-then logic jump. Each step can support multiple cut-off conditions and jumps.
- Special input methods: C-rate, OCV-SOC, Q%, ±V, Variable.
- Four-level Cycles: Single cycle up to 999,999 times, providing single step repeat and cycle time cut-off.
- Variable setting and cut-off conditions: 20 sets of variable setting include 2 variable functions for use across sub-recipes.
1ms~100ms transient capture of the variable at the start of the step, or records the test value at the start/end of the step and defines it as a variable for secondary calculation.
- Recipe protections: Voltage, Current, Chamber Temperature, Energy, Capacity, Current/Voltage Change, CC-CV/CP-CV Transition Time.

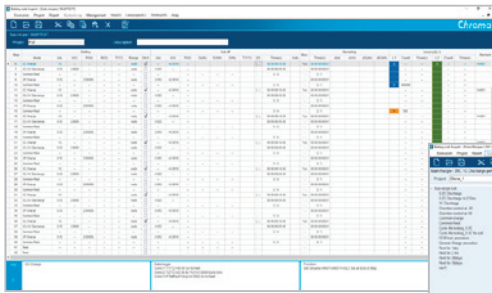

Sub-Recipe / Main Recipe / Test Plan Editor

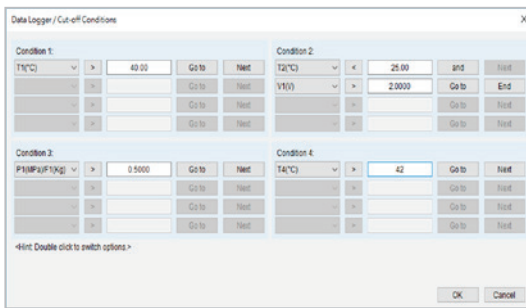
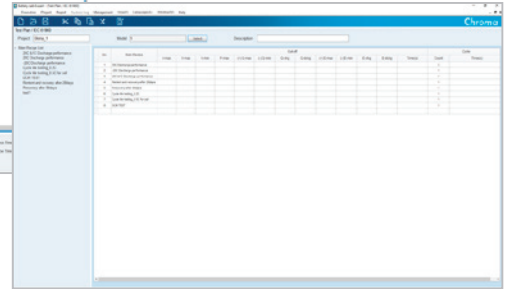
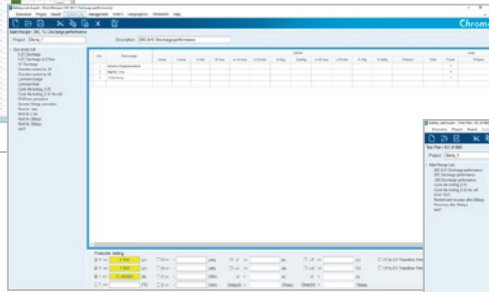

External Cut-Off Parameter

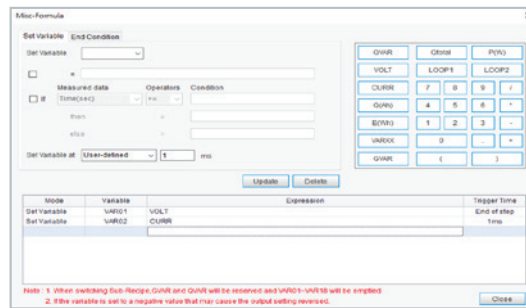

Variable Definition and Transient Capture

Recipe Executor

The recipe executor adopts group management according to different test plans. All channels in the group will simultaneously start testing and display their real-time test status. When integrated with a chamber, each channel will automatically perform a waiting mechanism, and the temperature control will not start until all the channels reach the same condition. When there are multiple groups in the chamber, they can be set to wait between groups.

- Control modes: Start, Pause, Resume, Stop, Reserved Pause, Skip, Specified Start, Pause to Jump, Preview.
- Real-time testing status display.
- Dynamic parallel settings.
- Multi-group start.

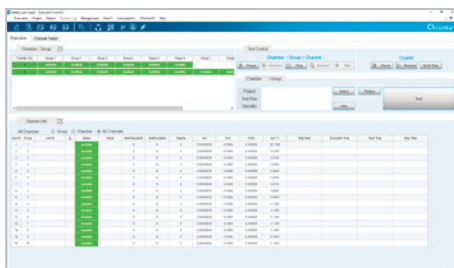

Recipe Executor

Real-time Chart Display

Display charging and discharging curves in real time while testing. Users can zoom in and out on data and display data values by dragging the mouse, as well as flexibly select any channel and axis item.

- Real-time charting based on the user-defined sampling time of up to 36,000 data points per screen.
- Up to 4 sets of real-time display screens, with test comparison for up to 2 channels per screen.
- Time freeze function to store test curves.
- Dual y-axis data display.



Real-time Chart Display

Test Report

- Auto report: after the sub-recipe finished testing, its data will be automatically exported to the path and file name set by the user.
- Export modes: auto export of sub-recipe, manual export of test plan.
- The system can adjust effective digits in the data up to 9 decimal places.
- Report types: channel report, step report.
- Free adjustment of the order of report items and field orders.

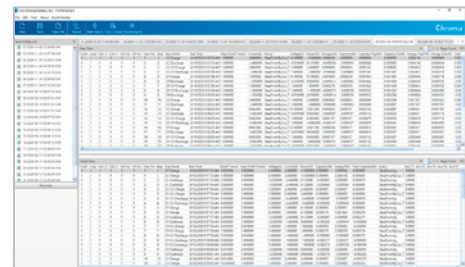
A screenshot of a test report preview window. It displays a large table with multiple columns and rows of data. The columns include various parameters and their values. The table is organized into sections, with a header row for each section. The data appears to be from a test run, showing various measurements and their corresponding values.

Test Report Preview

Chamber Control and System DI/DO Signal Control

- Triple chamber control: chamber control step, real-time remote control, and maintenance mode.
- Delay time: set the rest time after reaching the set temperature to secure similar temperatures between the DUT and chamber.
- Double temperature adjustment: the temperature logger adjusts the chamber to ensure that the chamber and DUT's actual temperature are the exact same.
- Chamber actions after testing: maintain, end, or adjust the temperature control.
- Dual chamber protection control: over-temperature and overtime.
- Tri-color warning light signal and relay signal are provided.

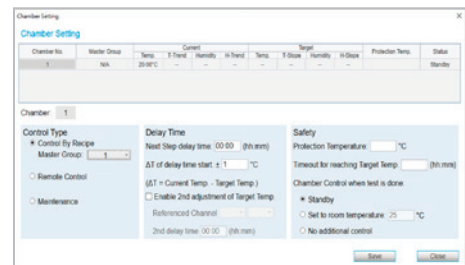
A screenshot of the 'Chamber Setting' dialog box. It contains several sections for configuring chamber control. The 'Control Type' section has radio buttons for 'Control By Recipe', 'Remote Control', and 'Maintenance'. The 'Delay Time' section includes fields for 'Next Step delay time', 'ΔT of delay time start', and '2nd delay time'. The 'Safety' section has fields for 'Protection temperature', 'Timeout for reaching target temp', and 'Chamber Control when test is done'. There are 'OK' and 'Cancel' buttons at the bottom.

Chamber Control Settings

Management

- Provide software account management and set multiple login accounts with corresponding editing permissions.
- Send exception warning messages via email.
- Import, export, and transfer test plans.

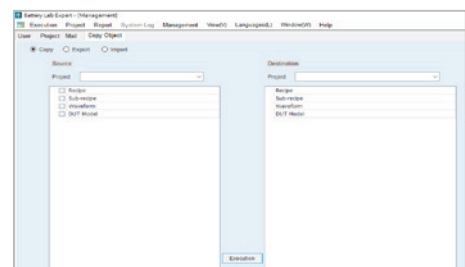
A screenshot of the 'Test Plan Import/Export' dialog box. It has a menu bar with options like 'File', 'Project', 'Management', 'Help', etc. Below the menu, there are radio buttons for 'Copy', 'Export', and 'Import'. The main area is divided into two panes: 'Source' and 'Destination'. Each pane has a list of items to be imported or exported. There is an 'Execute' button at the bottom.

Test Plan Import/Export

LITHIUM BATTERY TEST APPLICATIONS

Differential Voltage (dV/dQ)

The key to plotting the dV/dQ curve is to charge and discharge the battery with a small current (<C/20) in order to eliminate polarization effects on the test results. Chroma 17010 has low noise to draw high-definition dV/dQ vs. Q curves, users can view and mark each characteristic peak in detail. The ageing test allows users to analyze the battery's aging system based on the deviation and height of each characteristic peak.

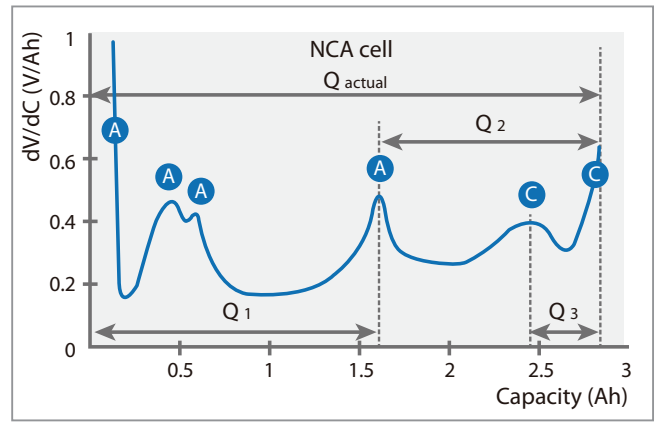

dV/dQ Test

Direct Current Internal Resistance (DCIR)

The battery's internal resistance value is related to its charge/discharge ratio. The larger the internal resistance value, the lower the efficiency when temperature rises. ACIR measurement of traditional 1KHz LCR meters can only evaluate the ohmic resistance (R_o) of the battery that affects the instantaneous power output, but is unable to evaluate the polarization resistance (R_p) produced during electrochemical reaction. DCIR assessment includes ACIR and comes closer to the actual polarization effect of the battery under continuous power application. Chroma 17010 has two programmable DCIR test modes, and – with the variable calculation function – can automatically obtain test results that meet the IEC 61960 standard.

- DCIR (1) is based on the voltage difference caused by one current change.
- DCIR (2) is based on the voltage difference caused by the change between two currents.

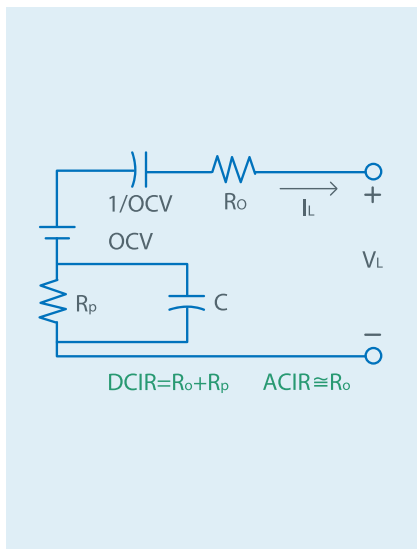

Li-ion battery Equivalent Circuit Model

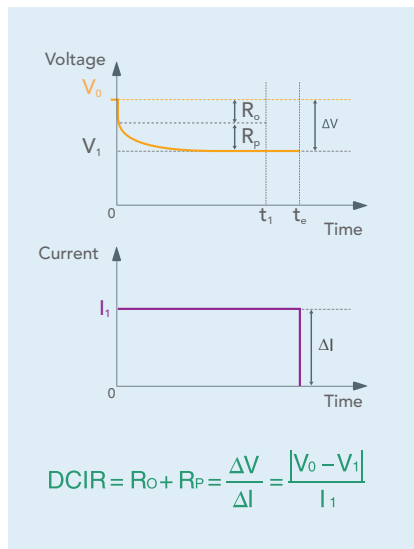

DCIR (1) Test

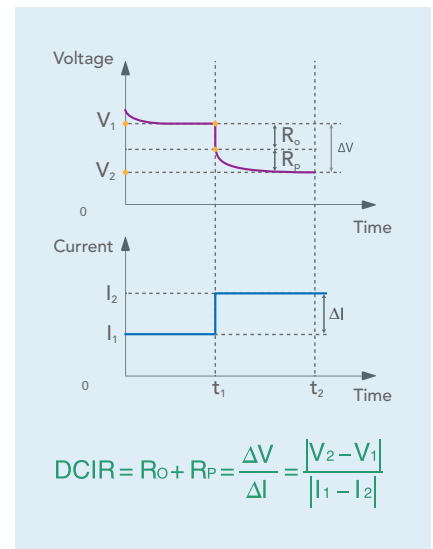

DCIR (2) Test

Hybrid Pulse Power Characteristic (HPPC)

Chroma 17010 has a flexible editing program that can compile HPPC test steps, as used by the U.S. Council for Automotive Research (USCAR) to evaluate the battery performance of new energy vehicles. The purpose is to obtain the open circuit voltage, ohmic resistance (Ro), and polarization resistance (Rp) data of a specific depth of discharge within the operating voltage range, following standard test methods. It establishes a functional relationship between the depth of discharge and the charge/discharge peak power, as an index to evaluate the battery cell's aging and output power capacity.

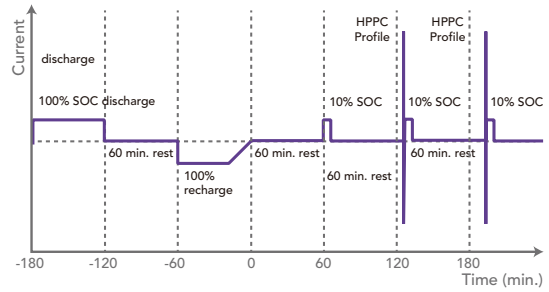

HPPC Test

Battery Capacity

The capacity can be obtained by integrating current over time, from the start of charging/discharging until the cut-off condition is reached. Common test items include current ratio and temperature characteristics. Comparing the results lets users analyze performance differences between products. Higher accuracy of current/voltage measurement and faster sampling enable to distinguish more accurately the differences in battery cell capacity.

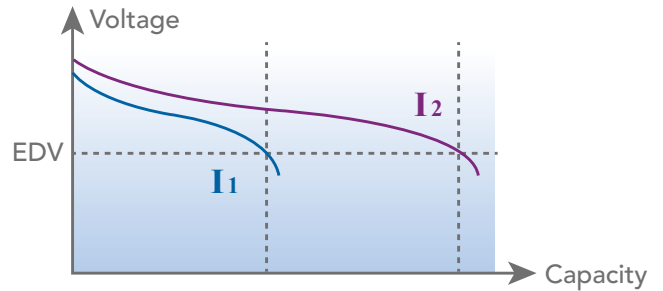

Battery Cycle Life

Cycle life is one of the most important test items for batteries. In accordance with the experimental purpose, it tests the same battery through repeated charge and discharge conditions until the capacity falls to 80%, and then calculates the number of cycles. The cycle life test can be used to evaluate battery performance or define proper conditions of use.

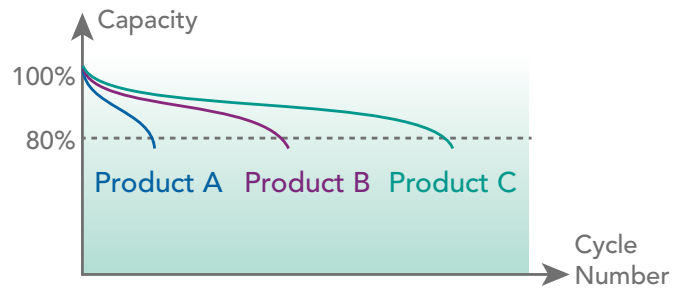

Coulombic Efficiency (CE)

CE is calculated by the charge/discharge capacity ratio when the battery is fully charged and then fully discharged. Good batteries have higher CE, and need high precision and stable equipment to distinguish differences. Chroma 17010 offers accurate CE testing that can estimate the battery lifespan with only a few cycles.

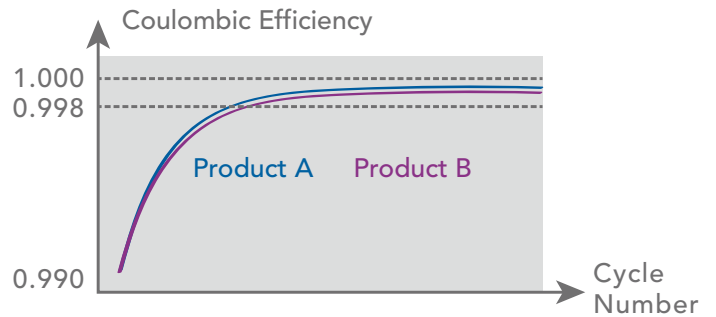

Coulombic Efficiency Test

Charge & Discharge Rate

The battery is charged and discharged at different currents to evaluate how its voltage platform and capacitance maintain. Such test results are often used for adjusting the proportion of active materials during product development as well as for verifying performance of power batteries for rapid charging and discharging.

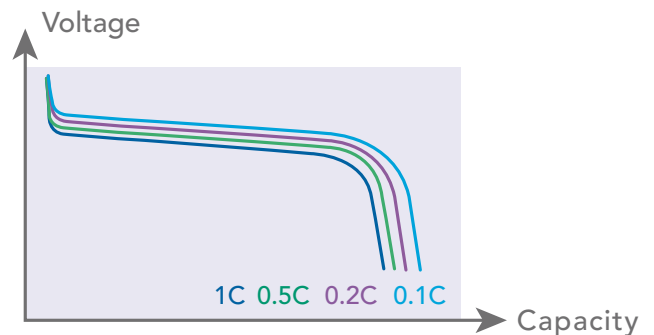

Charge & Discharge Rate

LITHIUM BATTERY TEST APPLICATION

Chroma 17010 Battery Reliability Test System meets the verification requirements of most international regulations in charge/discharge testing.

Type	Regulation	Standard Number	Test Items
IEC	Secondary lithium-ion cells for the propulsion of electric road vehicles – Part 1: Performance testing	IEC 62660-1 2010	7.1 General charge conditions 7.2 Capacity 7.3 SOC adjustment 7.4.1 Power test method 7.5.1 Energy test method 7.6 Storage test 7.7 Cycle life test 7.8 Common tests
	Secondary cells and batteries containing alkaline or other non-acid electrolytes – Secondary lithium cells and batteries for portable applications	IEC 61960 2011	7.3 Discharge performance 7.4 Charge(Capacity) retention and recovery 7.5 Charge(Capacity) recovery after long term storage 7.6 Endurance in cycle
GB/T	Cycle life requirements and test methods for traction battery of electric vehicle	GB/T 31484 2015	6.1 Test conditions 6.2 Capacity and energy under room temperature (initial capacity and energy) 6.3 Power under room temperature (initial power) 6.4 Standard cycle life 6.5 Operating-condition cycle life
	Electrical performance requirements and test methods for traction battery of electric vehicle	GB/T 31486 2015	6.2.4 Secondary cell charging 6.2.5 Discharge capacity under room temperature (initial capacity)
	General specification of lithium-ion cells and batteries for mobile phone	GB/T 18287 2013	5.3.2.1 Charging methods 5.3.2.2 0.2 ItA discharge 5.3.2.3 Rated discharge 5.3.2.4 High temperature discharge 5.3.2.5 Low temperature discharge 5.2.3.6 Charge retention capability and recovery capacity 5.3.2.7 Storage performance 5.3.2.8 Cycle life 5.3.3.2 Steady damp-heat
USABC	Battery Test Manual for 48 Volt Mild Hybrid Electric Vehicles	Rev.0 2017	3.2 Static Capacity Test 3.3 Constant Power Discharge and Charge Tests 3.4 Hybrid Pulse Power Characterization Test 3.5 Standard Self Discharge Test 3.6 Cold Cranking Test 3.7 Thermal Performance Test 3.8 Energy Efficiency Test 3.9 Operating Set Point Stability Test 3.10 Cycle Life Test 3.11 Calendar Life Test
	Battery Test Manual for 12 V Start/Stop Vehicles	Rev.2 2018	3.2 Static Capacity Test 3.3 Constant Power Discharge and Charge Tests 3.4 Hybrid Pulse Power Characterization Test 3.5 Standard Self Discharge Test 3.6 Cold Cranking Test 3.7 Thermal Performance Test 3.8 Energy Efficiency Test 3.9 Operating Set Point Stability Test 3.10 Cycle Life Test 3.11 Calendar Life Test
	Battery Test Manual for Electric Vehicle	Rev.3.1 2020	3.2 Static Capacity Test 3.3 High Rate Charge 3.4 Hybrid Pulse Power Characterization Test 3.5 Peak Power Test 3.6 Self-Discharge Test 3.7 Thermal Performance Test 3.8 Life Testing 3.9 Cycle Life Dynamic Stress Tests 3.10 Calendar Life Test
	Battery Test Manual for Plug In Hybrid Vehicle	Rev.3	3.2 Static Capacity Test 3.3 Constant Power Discharge Tests 3.4 Hybrid Pulse Power Characterization Test 3.5 Self-Discharge Test 3.6 Cold Cranking Test 3.7 Thermal Performance Test 3.8 Energy Efficiency Test 3.9 Life Testing 3.10 Charge-Sustaining Cycle Life Tests 3.11 Charge-Depleting Cycle Life Test Profile 3.12 Calendar Cycle Life Test

BATTERY CELL TEST SYSTEM AUTO CALIBRATOR

Chroma A170103 is a complete automated calibration and verification equipment with a variety of high-precision calibration standard components built-in for programmable test tasks. Chroma A170103 applies to Chroma 17010 products up to 150A in order to ensure that the equipment maintains its high precision and traceability.

- Consistent standards verification: reducing human errors and test variables.
- Efficient calibration and verification: cutting down labor costs.
- Automated report generation: managing maintenance records and traceability.



Specifications	
Voltage	0~10V
Current	1mA/10mA/100mA/1A/6A/30A/150A (7 ranges)
Channels	16CHs/time
Input	Single-phase AC 100V~120V / Single-phase AC 200V~240V ± 10%. (manual switch)
Dimensions (W x D x H) (mm)	600 x 900 x 1100
Weight (Kg)	<150
Equipment	
Standard	A170103, A820001 S/W, IPC & Windows 10 & Office, RS-485 card, 7230 I/O card
Option	30ppm digital DMM, Monitor, Keyboard & mouse

ENVIRONMENTAL & EXTERNAL SPECIFICATIONS

Environmental and External Specifications		
Operating temperature	0°C~40°C	
Operating humidity	<90 RH%	
Input	3 Φ 200~220Vac ± 10% V _{LL}	
	3 Φ 380~400Vac ± 10% V _{LL}	
	Frequency 47~63Hz	
Dimensions (W x D x H) (mm)	25U	600 x 1100 x 1340
	36U	600 x 1100 x 1830
	41U	600 x 1100 x 2060
Weight (Kg)	25U	<160
	36U	<370
	41U	<510

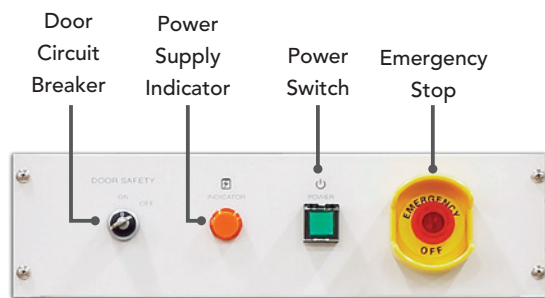

Emergency Panel

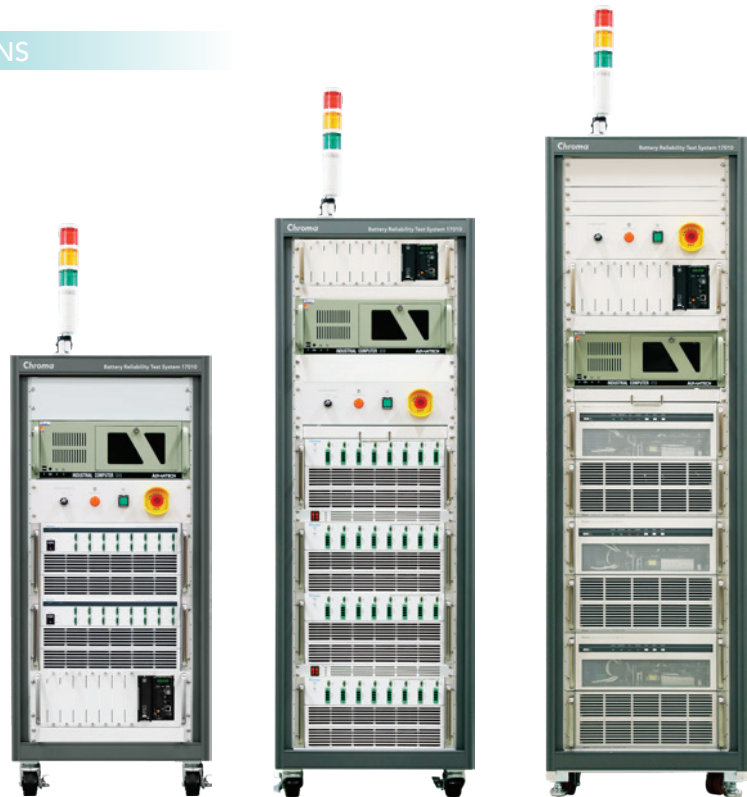

25U Rack

36U Rack

41U Rack

SPECIFICATIONS - 1

System	17010						
Model	Current Range	Power Range	Super Mode	0V Discharge	Regenerative Mode	Channels	Rack
17216-6-6	6A/1.2A/0.6A/1mA	0~6V	--	--	--	16/32/48/64/80/96	19" (25U) (36U) (41U)
17216-6-12	12A/2.4A/1.2A/1mA	0~6V	--	--	--	16/32/48/64/80/96	
17216M-10-6	6A/0.2A/6mA/0.2mA	0~10V / 0~5V / ±5V	--	Yes	--	16/32/48/64/80/96	
17216M-6-12	12A/3A/1A/0.1A	0~6V	--	Yes	--	16/32/48/64/80/96	
17208M-6-30	30A/10A/0.1A/1mA	0~6V	--	Yes	--	8/16/24/32/40/48/56/64	
17208M-6-60	60A/15A/5A/0.5A	0~6V	--	Yes	--	8/16/24/32/40/48/56/64	
17212M-6-100S	100A/50A/25A	0~6V	Yes	--	Yes	12/24/36/48	

* Continued on next page

SPECIFICATIONS - 2

Model		17216-6-6					17216-6-12			
Voltage										
Accuracy		±0.015% of F.S.								
Range		Charge 0V~6V ; Discharge 1.5V~6V					Charge 0V~6V ; Discharge 1.5V~6V			
Resolution	Output	1mV								
	Reading	0.1mV								
Current										
Accuracy		6A : ±0.02% of F.S. Others : ±0.04% of F.S.					12A : ±0.02% of F.S. Others : ±0.04% of F.S.			
Range		1mA	0.6A	1.2A	6A	1mA	1.2A	2.4A	12A	12A
Resolution	Output	0.1μA	0.1mA	1mA	1mA	0.1μA	1mA	2mA	10mA	10mA
	Reading	0.01μA	10μA	0.1mA	0.1mA	0.01μA	0.1mA	0.2mA	1mA	1mA
Power										
Accuracy		36W : ±0.035% of F.S. Others : ±0.055% of F.S.					72W : ±0.035% of F.S. Others : ±0.055% of F.S.			
Range		6mW	3.6W	7.2W	36W	6mW	7.2W	14.4W	72W	72W
Resolution	Output	1μW	1mW	1mW	10mW	1μW	1mW	1mW	10mW	10mW
	Reading	0.1μW	0.1mW	0.1mW	1mW	0.1μW	0.1mW	0.1mW	1mW	1mW
Data Record		10mS								
Current Rise Time (+10%~+90%)		500μS					500μS			

Model		17216M-10-6					17216M-6-12			
Voltage										
Accuracy		±0.015% of F.S.								
Range		0V~10V, 0V~5V or -5V~5V					0V~6V			
Resolution	Output	1mV								
	Reading	0.1mV								
Current										
Accuracy		± 0.02% of F.S.					± 0.02% of F.S.			
Range		200μA	6mA	200mA	6A	100mA	1A	3A	12A	12A
Resolution	Output	0.1μA	1μA	0.1mA	1mA	0.1mA	1mA	1mA	10mA	10mA
	Reading	0.01μA	0.2μA	0.01mA	0.2mA	0.01mA	0.1mA	0.1mA	1mA	1mA
Power										
Accuracy		± 0.035% of F.S.					± 0.035% of F.S.			
Range		2mW	60mW	2W	60W	600mW	6W	18W	72W	72W
Resolution	Output	1μW	10μW	1mW	10mW	0.1mW	1mW	10mW	10mW	10mW
	Reading	0.1μW	2μW	0.1mW	2mW	10μW	0.1mW	1mW	1mW	1mW
Data Record		10mS								
Current Rise Time (+10%~+90%)		100μS					250μS			

Model		17208M-6-30					17208M-6-60			17212M-6-100S			
Voltage													
Accuracy		±0.015% of F.S.									±0.02% of F.S. *1		
Range		0V~6V									Charge 0V~6V ; Discharge 1.5V~6V		
Resolution	Output	1mV									1mV		
	Reading	0.1mV									0.1mV		
Current													
Accuracy		±0.02% of F.S.					±0.02% of F.S.			±0.05% of F.S. *1			
Range		1mA	100mA	10A	30A	500mA	5A	15A	60A	25A	50A	100A	120A(RS)
Resolution	Output	1μA	0.1mA	10mA	10mA	0.1mA	1mA	10mA	10mA	1mA	5mA	10mA	10mA
	Reading	0.1μA	0.01mA	1mA	1mA	0.01mA	0.1mA	1mA	1mA	0.1mA	0.5mA	1mA	1mA
Power													
Accuracy		±0.035% of F.S.					±0.035% of F.S.			±0.07% of F.S.			
Range		6mW	60mW	60W	180W	3W	30W	90W	360W	150W	300W	600W	720W
Resolution	Output	1μW	0.1mW	10mW	10mW	1mW	10mW	10mW	100mW	10mW			
	Reading	0.1μW	10μW	1mW	1mW	0.1mW	1mW	1mW	10mW	1mW			
Data Record		10mS											
Current Rise Time (+10%~+90%)		250μS					250μS			1mS			

Note*1: Short-term output capability (ST) can output 120% constant current / constant power in a maximum 30S within 60S.
Current accuracy ±0.1% of F.S., power accuracy ±0.12% of F.S.

* All specifications are subject to change without notice.

Get more product & global distributor information in Chroma ATE APP



iOS



Android

Search Keyword

17010

HEADQUARTERS
CHROMA ATE INC.
88 Wenmao Rd.,
Guishan Dist.,
Taoyuan City
333001, Taiwan
T +886-3-327-9999
F +886-3-327-8898
www.chromaate.com
info@chromaate.com

U.S.A.
CHROMA ATE, INC.
(U.S.A.)
7 Chrysler, Irvine,
CA 92618
T +1-949-421-0355
F +1-949-421-0353
Toll Free +1-800-478-2026
www.chromaate.com
info@chromaus.com

EUROPE
CHROMA ATE EUROPE B.V.
Morsestraat 32,
6716 AH Ede,
The Netherlands
T +31-318-648282
F +31-318-648288
www.chromaate.com
salesnl@chromaate.com

CHROMA GERMANY GMBH
Südtiroler Str. 9, 86165,
Augsburg, Germany
T +49-821-790967-0
F +49-821-790967-600
www.chromaate.com
salesde@chromaate.com

JAPAN
CHROMA JAPAN
CORP.
888 Nippa-cho,
Kouhoku-ku,
Yokohama-shi,
Kanagawa,
223-0057 Japan
T +81-45-542-1118
F +81-45-542-1080
www.chroma.co.jp
info@chroma.co.jp

KOREA
CHROMA ATE
KOREA BRANCH
3F Richtogether
Center, 14,
Pangyojeok-ro 192,
Bundang-gu,
Seongnam-si,
Gyeonggi-do
13524, Korea
T +82-31-781-1025
F +82-31-8017-6614
www.chromaate.co.kr
info@chromaate.com

CHINA
CHROMA ELECTRONICS
(SHENZHEN) CO., LTD.
8F, No.4, Nanyou Tian
An Industrial Estate,
Shenzhen, China
T +86-755-2664-4598
F +86-755-2641-9620
www.chroma.com.cn
info@chromaate.com

SOUTHEAST ASIA
QUANTEL PTE LTD.
(A company of Chroma Group)
25 Kallang Avenue #05-02
Singapore 339416
T +65-6745-3200
F +65-6745-9764
www.quantel-global.com
sales@quantel-global.com

株式会社マックスシステムズ

URL ; <https://www.macsystems.co.jp>